

# Simpleware Software Solutions for Materials & Manufacturing

From 3D Images to Models



# Applications in Materials & Manufacturing

## Complex Material Modeling

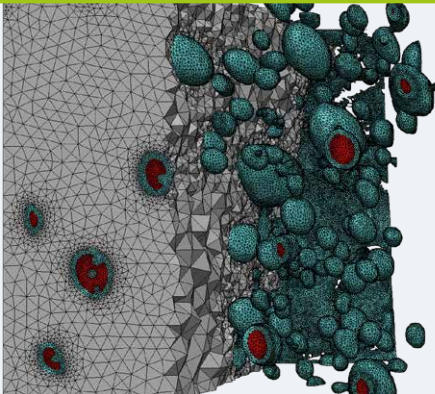

### Multi-Phase Material Meshes

- Optimized segmentation for multi-phase, granular and porous materials
- Automatic material/grain/pore distribution analysis and multi-phase material meshing
- FE-based linear homogenization for mechanical, flow and thermal properties

## Digital Rock Physics

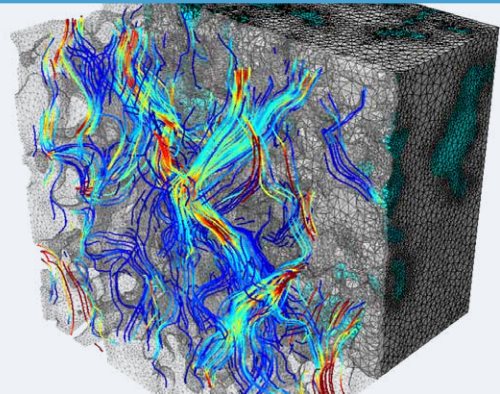

### Characterizing Porous Media

- Automated and semi-automated segmentation to characterize pore space
- Use patented meshing technology to accurately represent flow path geometry
- Calculate absolute permeability from image data using fully integrated Stokes Solver in Simpleware FLOW

## Non-Destructive Evaluation

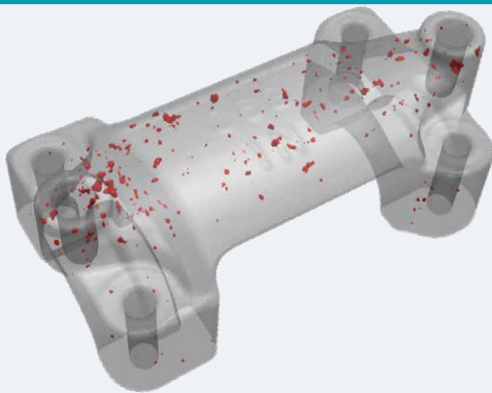

### Visualize and Quantify Defects

- Use automated and semi-automated segmentation tools to model manufacturing defects
- Compare image and CAD data and inspect defects using automated wall thickness or deviation tools
- Characterize features/defects/pores using Simpleware's extensive statistical framework and reports

## Reverse Engineering

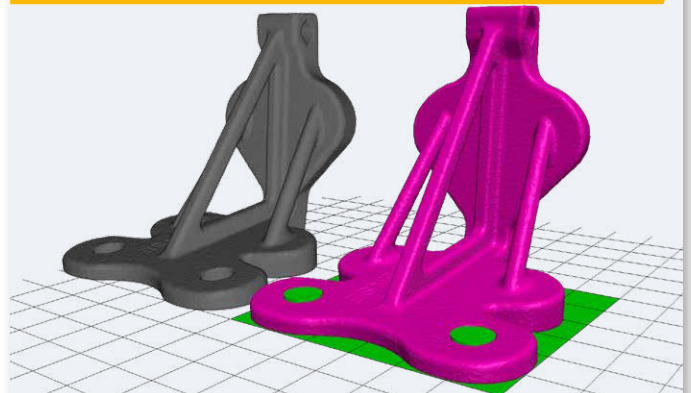

### High Value Part Models from Images

- Build a digital twin using multiple sets of image data to capture important features
- Qualify internal geometries with shape fitting and centerline statistic tools
- Export multi-part simulation-ready meshes (for FE or CFD) to determine part viability or life span without CAD idealization

# From Image Processing to Model Generation

## Image Processing

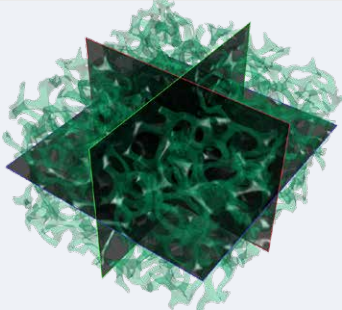

### Import & Registration

#### Modalities

- CT / Micro-CT / Nano-CT
- FIB-SEM
- 3D EBSD
- Synthetic data (e.g. DREAM.3D)

#### Formats

- Raw image data (RAW, IMG, VOL...)
- 2D image stacks (BMP, JPEG, TIFF...)
- DICONDE
- DICOM
- 3D mesh files

#### Options

- Automatic snap and landmark-based registration in 2D and/or 3D of multiple datasets

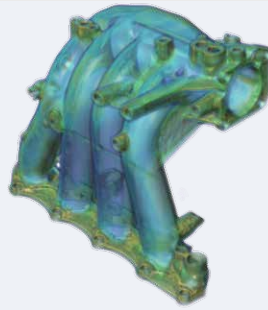

### Visualization & Image Processing

#### Volume and Mask Rendering

- Fast and memory efficient
- GPU rendering
- 3D live mode for instant updates
- Clipping and opacity settings
- 3D stereo mode options

#### Image and Mask Filters

- Noise reduction
- Smoothing and morphological filters
- Wide range of image transforms

#### Visualization

- Animations creation and export
- Interactive image reslicing using multiplanar reconstruction mode
- Export 3D PDFs

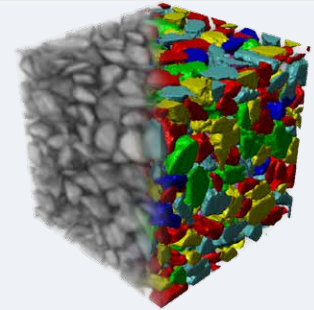

### Segmentation Tools

#### Automated and Semi-Automated Segmentation

- Local surface correction
- Region growing and magnetic lasso
- Multilevel Otsu segmentation
- Threshold, floodfill and painting
- 3D editing tools
- Automated watershed-based particle separation tool
- Image-space lofting (interpolation) tool
- Split tool to automatically separate regions
- Greyscale-based slice-to-slice propagation and interpolation

## The Simpleware Solution

Synopsys Simpleware™ software provides an industry-leading, comprehensive 3D image processing platform for handling 3D scan data. Accurately process images with a wide range of tools for visualizing data, obtaining image statistics and carrying out segmentation, right through to generating 3D printing and simulation-ready models.

## Improve Materials & Manufacturing Workflows

Simpleware software is accessible to both beginners and more advanced users. The intuitive interface provides quick-and-easy access to a range of powerful tools. Customization options, such as the 'My tools' tab and scripting, allow automation of workflows, making it easy to handle data from multiple samples and save time when working with complex datasets.

# From Image Processing to Model Generation

## Surface Tools

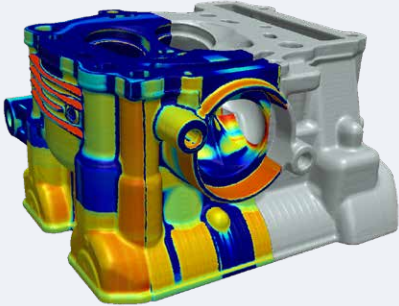

### Working with Image & CAD Data

- Import CAD files (STL, STEP, IGES), work with them independently or integrate them into models
- Automatic fixing of erroneous CAD data on import
- Automatic registration with snap tool for alike surfaces
- Landmark registration tools for positioning CAD in image data
- Preserve CAD feature edges when combined with image data
- Surface deviation analysis for CAD and image data comparisons
- Sweep pipes/tubes along centerlines
- Import and interactively position SOLIDWORKS® parts or assemblies with 3D image data\*
- Automatically update design changes made in SOLIDWORKS®

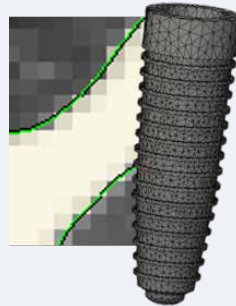

### Surface Mesh Generation

- High quality meshes (no post-processing/fixing)
- Volume and topology preserving smoothing
- Feature-based decimation
- Advanced options to control mesh properties
- Conforming multi-part surfaces
- Range of surface mesh exports
- Mesh quality histogram for mesh inspection

#### Inspect and Export Surface Models

- Inspect model quality for errors and warnings
- Pin-point inspection locations within the image/segmentation
- Export surface meshes (STL, OBJ, 3MF...)

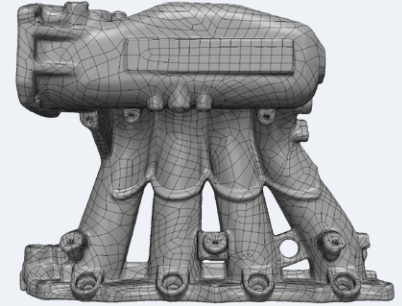

### NURBS Model Generation

- Create NURBS models for use in CAD packages
- Automated NURBS patch fitting
- Choice of algorithms
- Highly accurate conversion
- Inspection tool to check models
- Models suitable for further design work/simulation
- Export NURBS surfaces as STEP or IGES

## Combine Image and CAD Data

Unique capabilities allow you to integrate CAD models within 3D image data to obtain comparisons of scans of as-built parts with original CAD designs. Avoid the challenge associated with combining multiple sources of data in different formats by working directly in Simpleware software, with additional options for synchronizing models with SOLIDWORKS®.

\*Not available in the Linux operating system

## Customize Your Workflow with Scripting

All functionality within Simpleware products is accessible from a fully documented API, with bindings available for Python and C#. Use this API to automate repeatable workflows, build wizards and integrate custom plugins. By using our macro recording functionality, you can generate code without needing any prior experience.

# From Image Processing to Model Generation

## Volume Mesh Tools

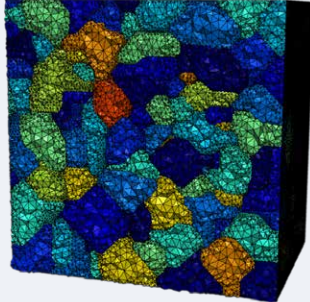

### Meshing for FEA & CFD

- Conforming multi-part volume meshes
- Feature-based and user-defined mesh refinement
- Per-part meshing controls
- Define contacts, node sets and shells
- Boundary layer meshing for CFD
- Automated positioning of CFD clipping planes
- Dedicated exports for major FEA & CFD solvers
- Optimize element qualities against multiple metrics
- Import and remesh existing volumetric meshes

## Measurements

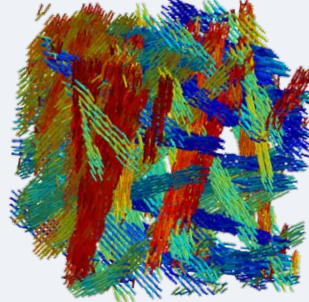

### Measurements & Statistics

#### Interactive Tools

- Quick measurements/statistics
- Measure volumes, surface areas, orientations, distributions
- Wall thickness assessment
- Shape fitting and analysis
- Deviation analysis
- Fibre, pore and particle analysis

#### Image Statistics Framework

- Generate templates, test reports...
- Quantify phases, grains, fractures, pores, particles...
- Centerline fitting, editing and analysis within dedicated tools
- Assess statistics globally or in local regions of interest
- Export raw or processed statistical data in a range of formats

## 3D Printing

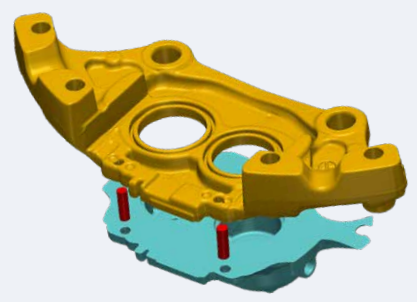

### 3D Printing Toolkit

- Prepare models using dedicated tools including: cut, hollow, emboss text, create connectors
- Create interlocking 3D parts using pins-and-sockets
- Analysis and inspection tools to check the model before export

#### Export Formats

- 3MF
- STL
- OBJ
- PLY
- 3D PDF
- VRML

## From Image to Mesh

Simpleware software offers a direct route from image data to simulation. Generated meshes are ready to use in the FE/CFD solver of your choice, with extensive options for tailoring your models to different simulation requirements. Rely on software that generates simulation-ready models, with no need for post-processing or fixing. Export directly to all major solver formats.

## Fast Quantitative Analysis

With quick, push-button statistics and measurement options, Simpleware software offers an easy way to carry out quantitative analysis on different types of data. The extended statistical framework provides you with a broad range of pre-defined templates, as well as the flexibility and ability to input custom functions and create custom templates.

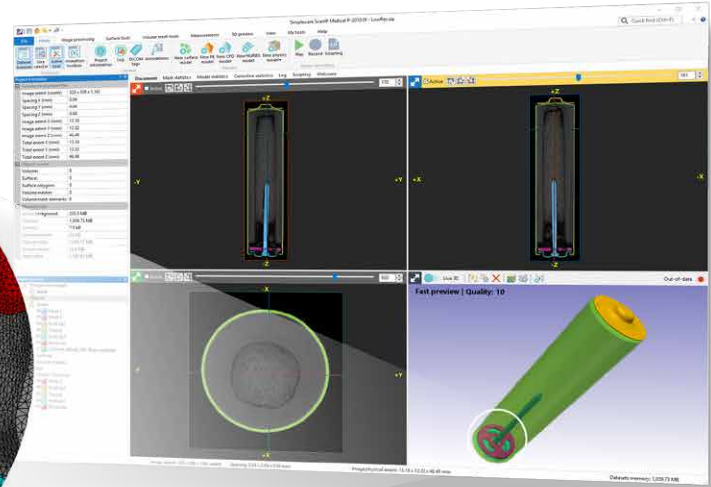
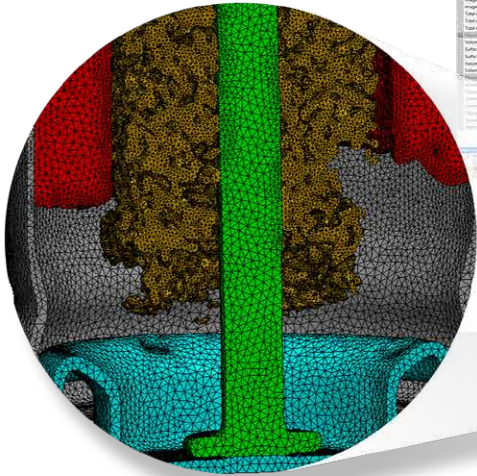

## Custom Model Generation and Services

Our service team can generate models for any application. We will work with you to develop a model, or series of models, that are tailored to your specific needs. This can be based on your own scan data or we can work from our library of high resolution image datasets.

## Training at All Levels

Receive step-by-step training on all areas of Simpleware software. We offer classroom training courses at local Synopsys offices or at your site, as well as customized one-to-one sessions at your place of work, or through web meetings. Our interactive courses include a combination of lectures, demos and hands-on tutorials.

## Expert Support for Your Requirements

All licenses come with full support from our team of experts. Our engineers can help you develop unique workflows, ensuring your use of the software is as efficient as possible, and your final output matches your requirements. Our support is offered via email, phone or web meetings, or we can even visit you on-site. Contact us at if you have any questions.

## Try Simpleware Software

Try the software for yourself with a free evaluation version, available on our website. The trial is fully functional and gives you access to the complete Simpleware software suite, full range of tutorials and technical support.

For more information, go to [www.synopsys.com/simpleware](http://www.synopsys.com/simpleware)

Email: [simpleware@synopsys.com](mailto:simpleware@synopsys.com)

Follow us:   



**SYNOPSYS**<sup>®</sup>  
Silicon to Software<sup>™</sup>

©2024 Synopsys, Inc. All rights reserved. Synopsys is a trademark of Synopsys, Inc. in the United States and other countries. A list of Synopsys trademarks is available at [synopsys.com/copyright.html](http://synopsys.com/copyright.html). All other names mentioned herein are trademarks or registered trademarks of their respective owners.  
07/04/24.sw-brochure-materialsmanufacturing-letter.